

SI-14 REPORT COLLECTION  
REPRODUCTION  
COPY

LAMS-2391

C.3

# LOS ALAMOS SCIENTIFIC LABORATORY OF THE UNIVERSITY OF CALIFORNIA • LOS ALAMOS NEW MEXICO

## NUCLEAR EXPLOSIONS AS NEUTRON SOURCES

Talk Given at Plowshare Symposium  
San Francisco, California  
May 13-15, 1959

LOS ALAMOS NATIONAL LABORATORY



3 9338 00320 8641

## LEGAL NOTICE

This report was prepared as an account of Government sponsored work. Neither the United States, nor the Commission, nor any person acting on behalf of the Commission:

A. Makes any warranty or representation, expressed or implied, with respect to the accuracy, completeness, or usefulness of the information contained in this report, or that the use of any information, apparatus, method, or process disclosed in this report may not infringe privately owned rights; or

B. Assumes any liabilities with respect to the use of, or for damages resulting from the use of any information, apparatus, method, or process disclosed in this report.

As used in the above, "person acting on behalf of the Commission" includes any employee or contractor of the Commission, or employee of such contractor, to the extent that such employee or contractor of the Commission, or employee of such contractor prepares, disseminates, or provides access to, any information pursuant to his employment or contract with the Commission, or his employment with such contractor.

Printed in USA. Price \$ .50. Available from the  
Office of Technical Services  
U. S. Department of Commerce  
Washington 25, D. C.

LAMS-2391  
NUCLEAR EXPLOSIONS-PEACEFUL APPLICATIONS  
(TID-4500, 15th Ed.)

**LOS ALAMOS SCIENTIFIC LABORATORY**  
**OF THE UNIVERSITY OF CALIFORNIA    LOS ALAMOS    NEW MEXICO**

REPORT WRITTEN: May 1959

REPORT DISTRIBUTED: March 18, 1960

**NUCLEAR EXPLOSIONS AS NEUTRON SOURCES**

Talk Given at Plowshare Symposium  
San Francisco, California  
May 13-15, 1959

by

George A. Cowan

Contract W-7405-ENG. 36 with the U. S. Atomic Energy Commission

All LAMS reports are informal documents, usually prepared for a special purpose and primarily prepared for use within the Laboratory rather than for general distribution. This report has not been edited, reviewed, or verified for accuracy. All LAMS reports express the views of the authors as of the time they were written and do not necessarily reflect the opinions of the Los Alamos Scientific Laboratory or the final opinion of the authors on the subject.



## ABSTRACT

Data are presented from some experiments which have been performed at Los Alamos which uniquely required the intense neutron sources provided by nuclear explosions. These studies concerned the following subjects:

- 1) Symmetry of fission of  $U^{235}$  at individual resonance levels in the epithermal neutron region.
- 2) Synthesis of new elements.
- 3) Tracer studies of fallout from the upper stratosphere.

In my talk today I propose to demonstrate that nuclear explosions produce neutrons in quantities which are so large that they make possible new and significant scientific experiments. Because such experiments can be suggested, it seems reasonable, in fact, to refer to nuclear devices as new scientific instruments in the same sense that the cyclotron, the cosmotron, and the linear accelerator, for instance, are scientific instruments.

Fission explosions produce about  $2 \times 10^{23}$  neutrons per kiloton of fission energy. This number is important to the calculation of available neutron flux at an external target. However, it is also possible to expose internal targets which are blown up with the device and then recovered from the debris. The activation of such targets is dependent on the nvt or neutrons per  $\text{cm}^2$  available internally. This number is, typically, of the order of  $10^{23}$  neutrons per  $\text{cm}^2$  for fission devices.

Thermonuclear devices produce up to  $2 \times 10^{24}$  neutrons per kiloton of energy. This means that at a given yield up to ten times as many neutrons are available from a clean thermonuclear device as from a fission device. Internal neutron exposures can range from one to two factors of ten greater than are available in fission devices. These neutron fluxes are many factors of ten greater than are available on a reasonable time-scale from the best laboratory neutron sources available today. I shall return to this comparison later.

Now I wish to mention some actual experiments. Rather than describe entirely new and untried ideas, I shall briefly outline three experiments in which Los Alamos scientists have already participated.

The first of these was really an inadvertent experiment which was performed in 1952 and which has not been successfully repeated. Nevertheless,

with a reasonable effort, it could be repeated in a form which will produce new and worthwhile results. I refer to the 1952 discovery of the new elements einsteinium and fermium in the debris of the first large-scale thermonuclear explosion.

These elements were made by successive neutron capture in heavy metal nuclei. In order to reach mass 255, the highest mass number observed in the debris, it was necessary for uranium of mass 238 to add 17 neutrons to its nucleus, one neutron at a time. Very heavy nuclei can be made in the laboratory or, rather, in a very high flux reactor in somewhat the same way. However, the chain of events in the reactor is different because the nuclei are bombarded by neutrons for years in order to achieve masses as high as 255 and, therefore, these nuclei beta decay between successive neutron captures to nuclides of more or less long half-life. When a configuration is finally reached with a short half-life for spontaneous fission or alpha decay, the element-building sequence is broken and the chain is terminated. This probably happens in reactors at around mass 255. Somewhat higher mass numbers can be obtained in the laboratory with heavy ion bombardments such as have been used in the University of California Radiation Laboratory to produce elements 101, 102, and possibly, 103.

When a thermonuclear reaction is used to make new neutron-rich isotopes, the bombardment is so short that the half-life of the intermediate nuclide is not a limiting factor as it is in reactors. However, the short half-life of the end product may be the limiting factor in its identification and may require very rapid recovery and processing of the sample. A significant difference between explosive bombardment and heavy ion bombardment is that by the first method the new nuclides are made on the neutron-rich side of the

line of greatest stability and by the second method on the neutron-poor side. If neutron-rich isotopes of element 102 and heavier are to be made, the job will probably be accomplished by using a thermonuclear explosion as the neutron source.

If one assumes that neutron capture and destruction cross sections do not vary with increasing neutron number, the quantity of any product nuclide made in a given neutron sea may be calculated from the equation:

$$N_n = \frac{N_0^O \phi \sigma_c e^{-\phi \sigma_d}}{n!}$$

where

$n$  = number of neutrons added

$N_0^O$  = number of original atoms of target material

$\phi = \int \left( \frac{\text{neutrons}}{\text{cm}^3} \right) (\text{neutron velocity}) dt = \text{time-integral neutrons/cm}^2$

$\sigma_c$  = capture cross section

$\sigma_d$  = destruction cross section

Figure 1 illustrates the yield curves of heavy isotopes as a function of  $\phi\sigma$ . In order to obtain significant yields of very heavy isotopes, it is necessary that  $\phi\sigma$  be equal to 5 or greater. The highest flux reactor today would give values of  $\phi\sigma$  typically smaller than 1/yr. Nuclear devices which produce very large values of  $\phi\sigma$  can be designed. They can be exploded underground and a significant fraction of the debris can be recovered. In order to be successful as an experiment, the fraction recovered need be very much smaller than is necessary for the economic success of underground breeders. In fact, prompt recovery of one percent of the debris would be excellent. Such a fraction of the total could conceivably be recovered by a controlled

leak introduced into the main reaction chamber, leading to another underground chamber. After the explosion, the second chamber would be flushed with acid which would then be piped to a processing plant at the surface and the new isotopes would be quickly recovered and examined. By incorporating the separated fraction into a second explosive device and repeating the process, it is conceivable that one can bootstrap the heavy isotope fraction into a mass region far higher than that attainable by any other method.

The technique I have described would not only yield new heavy elements but would reproduce, on a small, controlled scale, the element building process in the stars and give us new insight into cosmological secrets.

Another experiment which Los Alamos carried out last fall involved use of the sharply pulsed neutron burst from a small nuclear explosion to bombard  $U^{235}$  with neutrons which were energy-resolved by time-of-flight techniques. Figure 2 shows the relationship between distance on the rim of the wheel and neutron energy. Figure 3 shows the arrangement at the Nevada Test Site. Figure 4 shows the active portion of the wheel as determined by autoradiograph techniques. Figure 5 shows the specific activity of  $Mo^{99}$  in  $U^{235}$ . Figure 6 shows the specific activity of  $Ag^{111}$ . Figure 7 and Table 1 show the structure in the ratio  $Ag^{111}/Mo^{99}$ . This ratio serves as a measure of the symmetry of fission at resonances in the epithermal energy region. From these data it was concluded that the symmetry of fission varies with neutron energy and that, indeed, the observations are consistent with a particular theoretical model of fission which predicts that the symmetry of fission at resonance will show one or another of two possible modes depending on the value of the spin of the compound nucleus at each resonance. These results are significant to the ultimate understanding of the basic mechanism of heavy element fission.

Perhaps the most significant aspect of this experiment is that it



demonstrated that nuclear explosions can produce very large fluxes of neutrons with well-defined energies in excess of thermal and that these neutrons can be used to bombard external targets. The fluxes obtained at the  $U^{235}$  target, which was 100' from the bomb, were  $10^{10}$  or more neutrons per  $cm^2$  per ev with an energy spread at half-width of the order of a few percent from energies below 10 ev to in excess of 100 ev. Figure 8 shows the actual flux on the wheel. By suitable design of moderator around the device, it would be possible to optimize fluxes in energy regions from 1 ev to 14 Mev.

Finally, Los Alamos took part in an experiment last year which can be described as a world-wide tracer experiment. As part of one of the high-altitude tests carried out last summer, a specific tracer activity,  $Rh^{102}$  with a 220 day half-life, was produced in large enough quantity by neutrons from the explosion to permit its identification in small air samples as the debris fell back to earth. It was planned that sufficient analyses would be made on a world-wide scale to permit estimation of the rate of mixing of the upper stratosphere with the lower stratosphere, a subject about which little is presently known. The data are still being taken, but the rate of  $Rh^{102}$  return is so slow that it has not yet been unambiguously detected from the high-altitude source. This, in itself, is a significant result.

This use of a nuclear device illustrates the fact that geophysical tracer experiments can be carried out on a world-wide scale without adding a significant amount of radioactivity to the present level in the biosphere. On the other hand, the amount of tracer activity required for such a world-wide investigation of the movement of the upper stratosphere is larger than could possibly be made in laboratory machines.

My reason for mentioning these three experiments is to indicate that some proposals have already been reduced to practice. The results from these experiments have added and are adding significantly to scientific information in several fields. Many more experiments can be suggested. A considerable number of such experiments can be carried out, if necessary, in such a way as to produce no detectable additions of radioactive material to the biosphere. They can be performed, in some cases, with devices which do not resemble classified military weapons but which more closely resemble fast reactors. Such experiments deserve the most careful consideration by scientists and those who are concerned with the responsibility for keeping our country at the highest possible level of scientific achievement.

TABLE I  
 Structure in  $Ag^{111}/Mo^{99}$  Ratio vs. Neutron Energy  
 for 10-Mil and 20-Mil  $U^{235}$  Plates

$Ag^{111}/Mo^{99}$ Maxima		$Ag^{111}/Mo^{99}$ Minima	
10-Mil	20-Mil	10-Mil	20-Mil
18.3 ev	19.7 ev	17.8 ev	17.8 ev
21.4 ev	21.7 ev	20.8 ev	20.9 ev
24.5 ev	24.4 ev	22.6 ev	23.0 ev
29 ev	27.4 & 29 ev	27.1 ev	25.4 & 28 ev
36 ev	37 ev	31.5 ev	31.9 ev
40 ev	40 ev	38 ev	39 ev
47 ev	46 ev	44 ev	44 ev
53 ev	53 ev	51 ev	51 ev

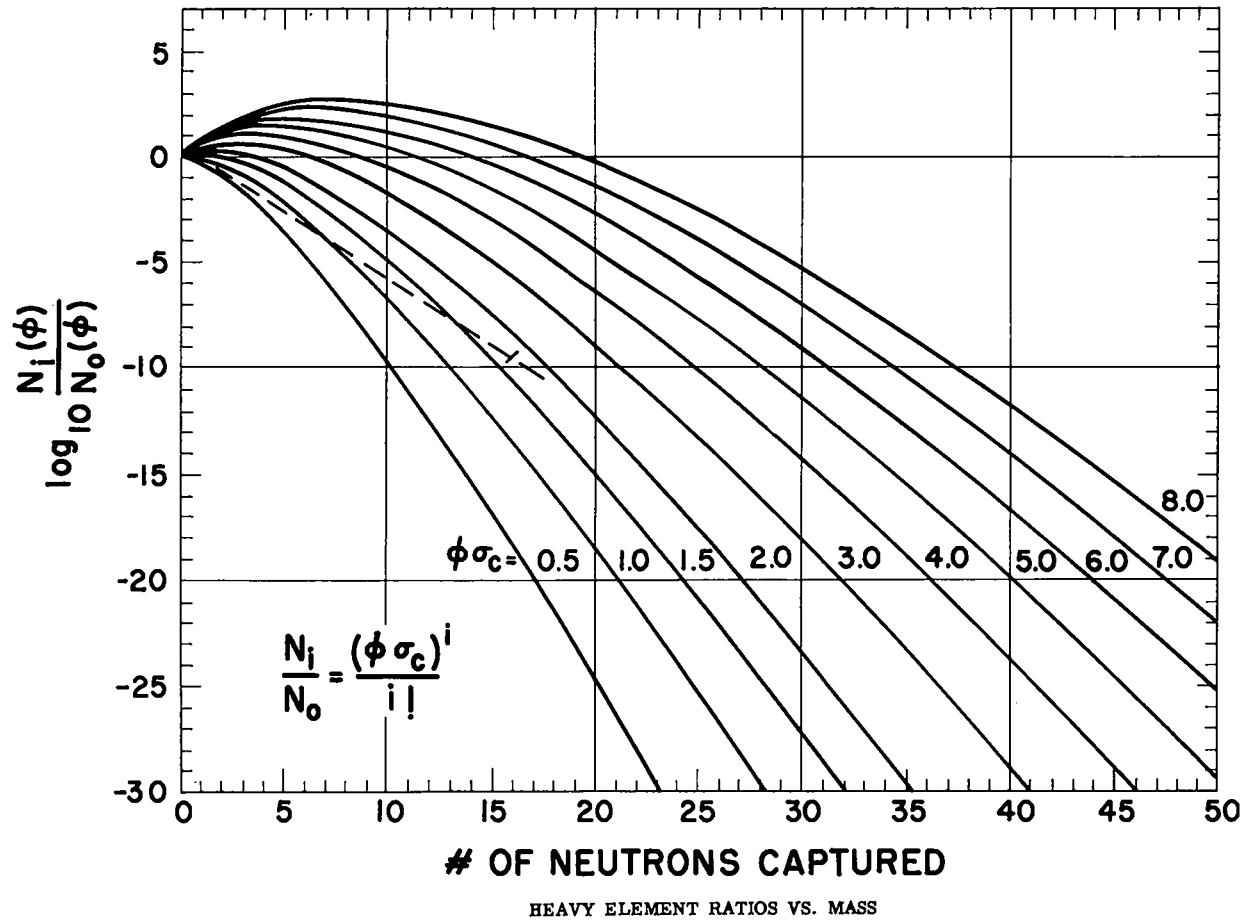

Figure 1.

$$S = \frac{V_{wh} D}{V_{n(1\text{ ev})} \sqrt{E_n}}$$

Figure 2.

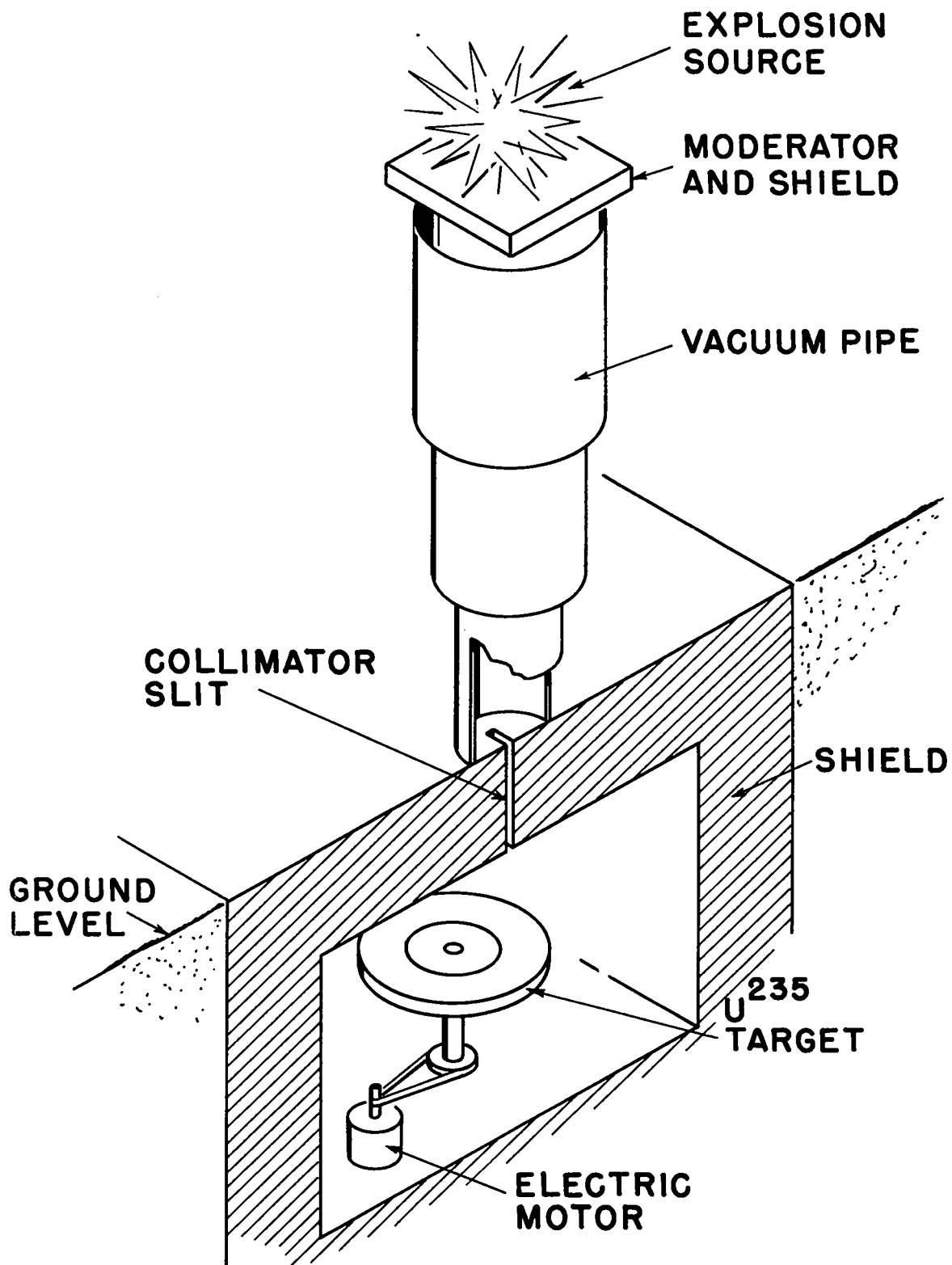

Figure 3.

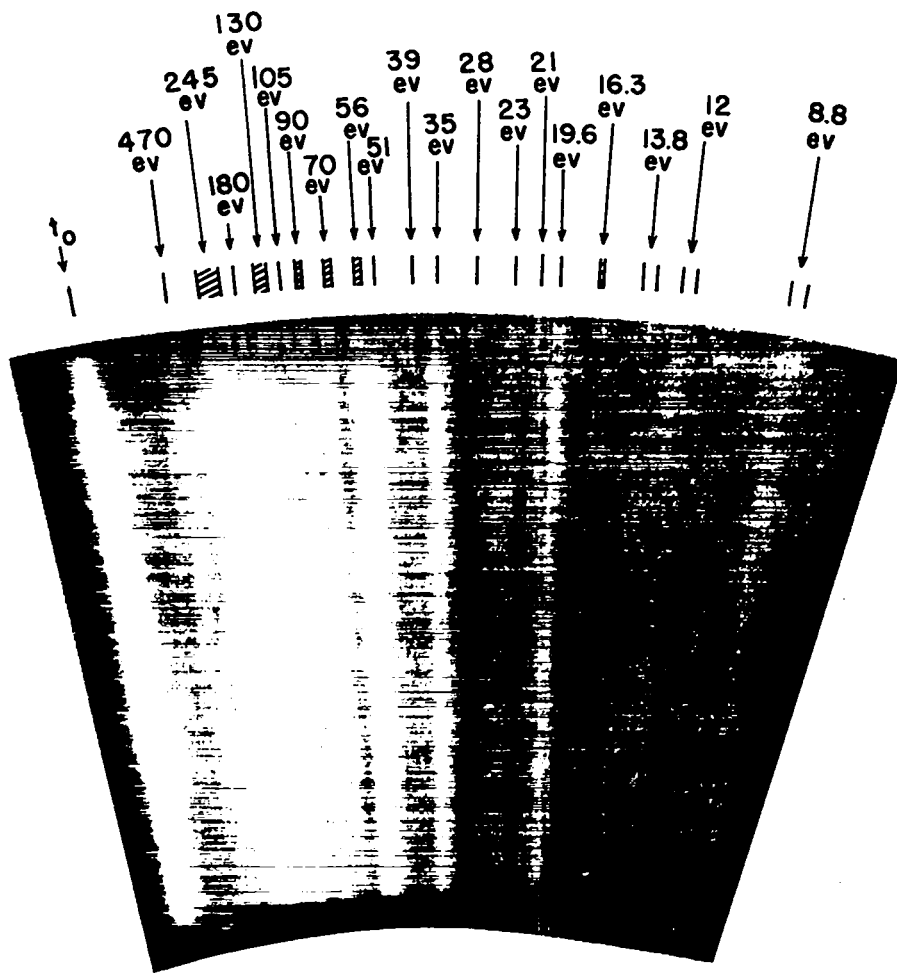

Figure 4.

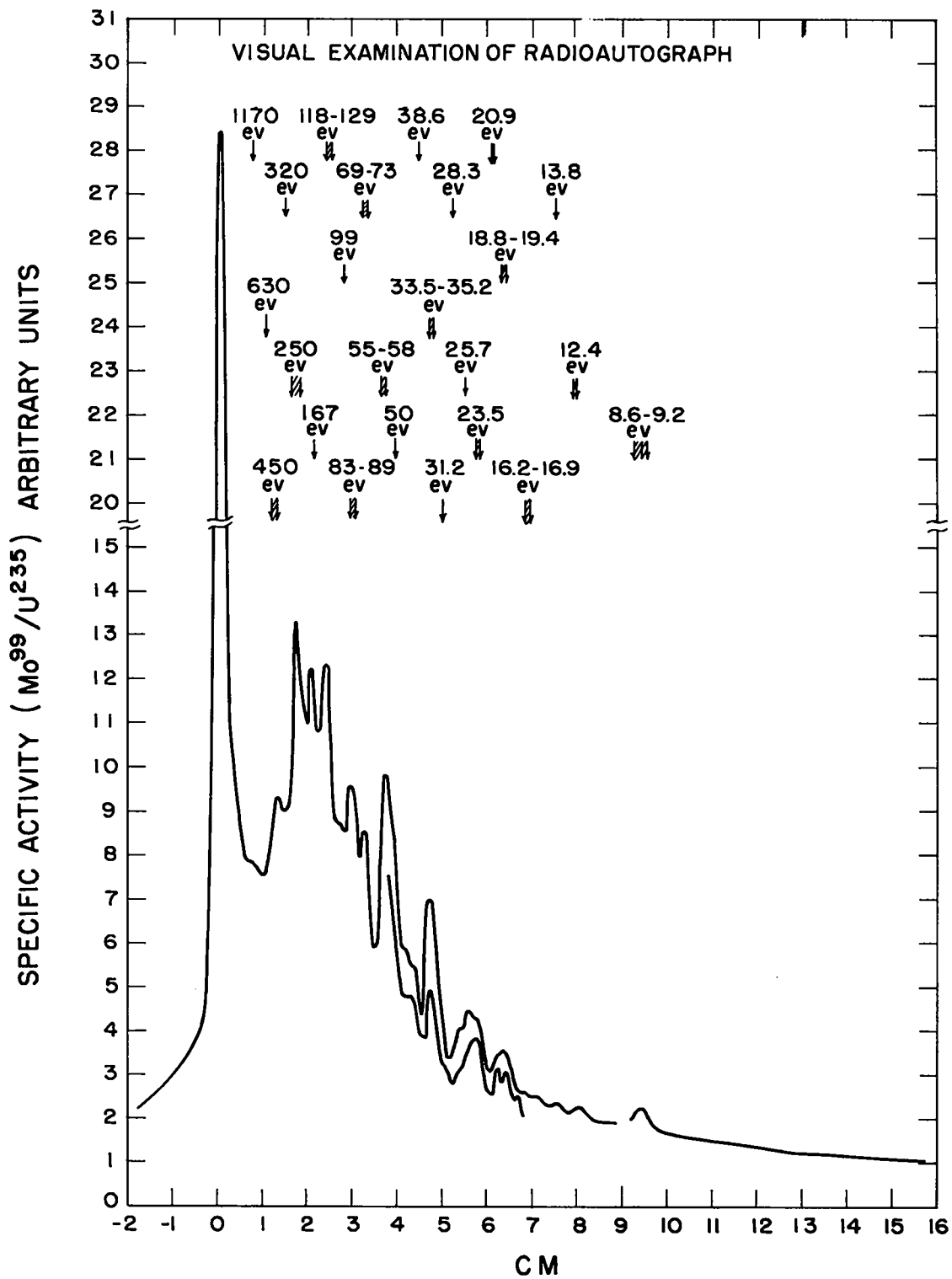

Figure 5.

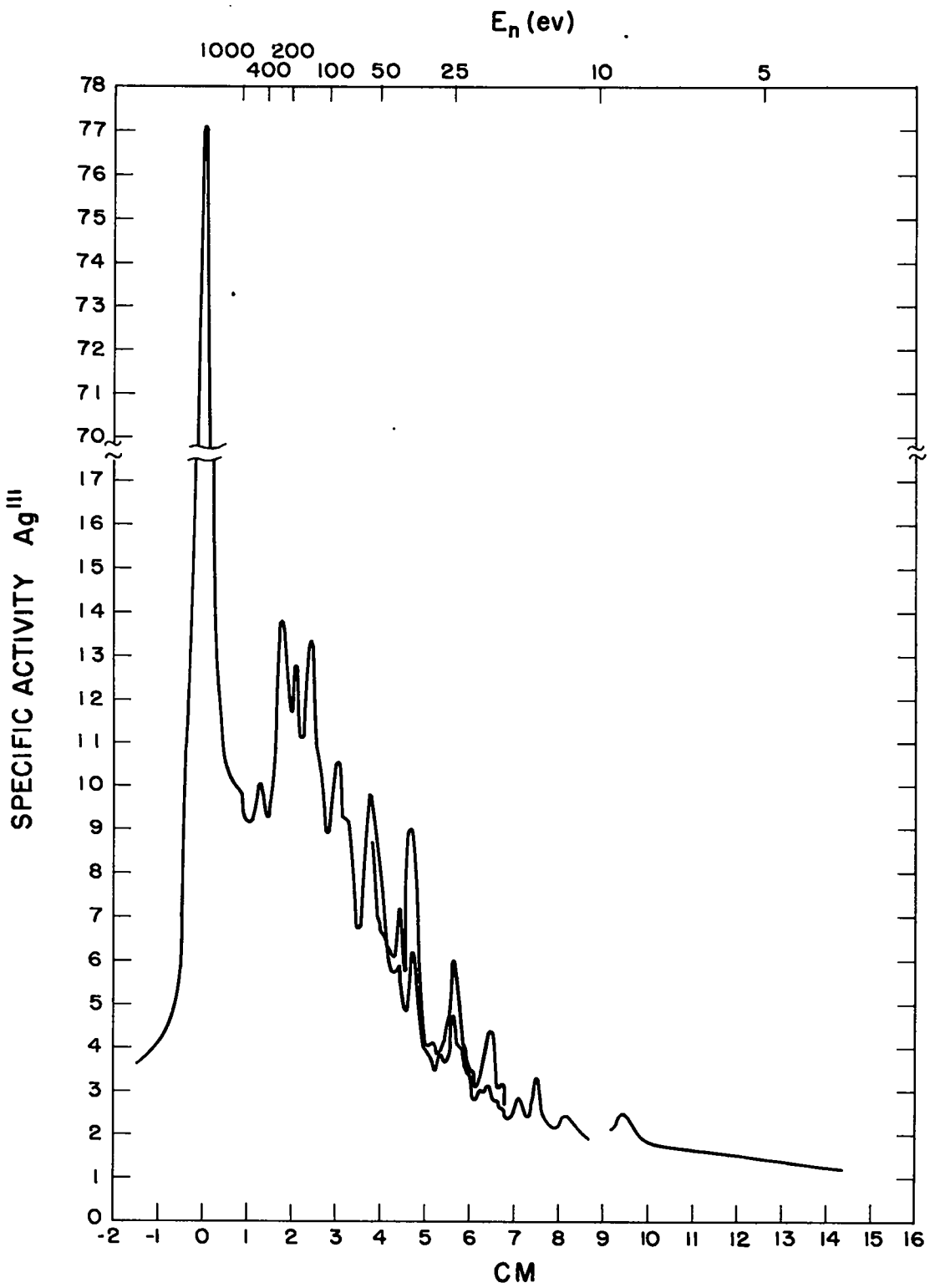

Figure 6.

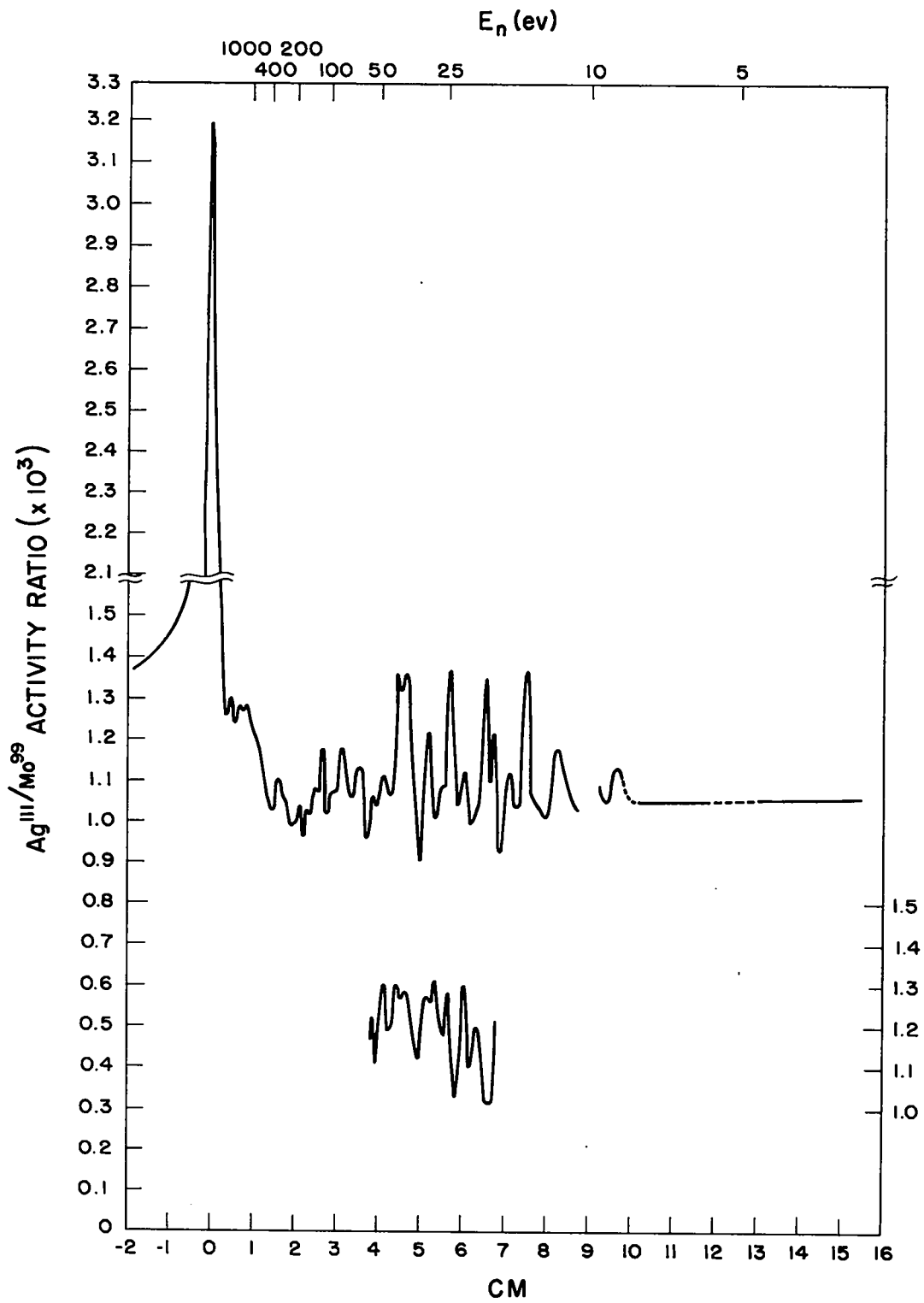

Figure 7.



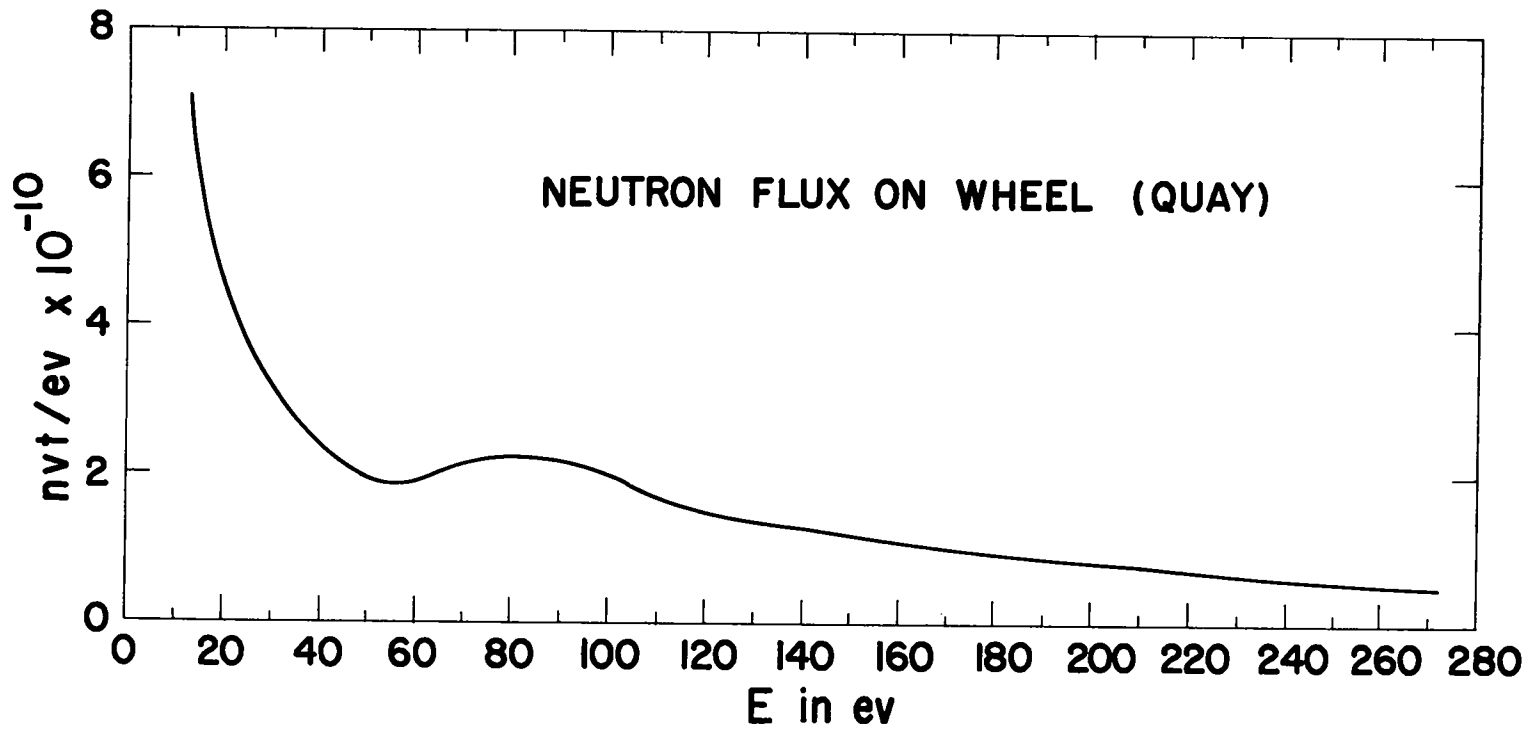

Figure 8.